

水槽 Milanello Workstation

右槽型

水槽

代码: 1040 851

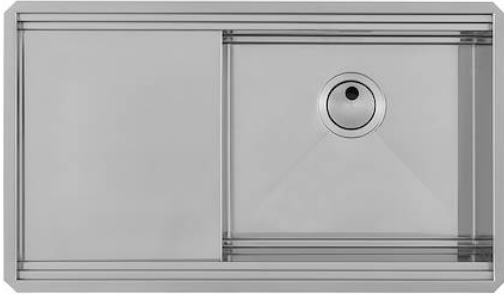

细节

材料 AISI 304 不锈钢

表面处理 拉丝 Foster

质地 磨砂

边型和安装方式 台下

底座 90 cm

尺寸 790x466 mm

标准配件 固定钩, 垫圈, 下水器, 溢水口和虹吸管, 纸板盒包装

龙头孔 无定位孔

安装孔 [View technical data sheet](#)

下水器 是

宽 79 cm

盆内尺寸 430x374mm

单槽/双槽 单槽

下水组件 下水器 SPACE 3,5"

特点

Space 下水器 SPACE不锈钢下水器的不锈钢盖子关闭了排水管，可隐藏任何残余物，将它们收集在下面的篮子里，令水槽显得格外优雅。SPACE还具有较小的占地面积，并且可以最佳地利用水槽下隔室。

三重滑轨 Foster Milano水槽使用巧妙的设计可以同时使用多个不同的附件。最上面一层，可以放置可滑动的创新的黑搁架，可以创造一个大的工作平面来冲洗食物和餐具。第二层用来放置和滑动通用配件，可以完成洗、冲、切、剁等多种功能。第三层靠近水槽底部，你可以放置冲洗过的食物餐具而不接触槽底，既可以沥水又不怕被槽底弄脏。

溢水口 溢水口是Foster水槽上的一项安全措施，可以防止疏忽时水的溢出。方形溢水解决方案，具有简约的方形，更加美观大方。

节省空间系统 下水器和虹吸管的设计目的是在水槽下方留出尽可能多的空间，如今对于这些单独的废物收集系统越来越有用。

钻石型底部 排水是水槽的一项重要功能，在Foster产品中始终要小心处理。在具有平底的弯曲焊接水槽中，优雅的斜角确保适当的排水，有助于水流。

高厚度 1mm厚的钢。相当大的厚度，保证了最大的坚固性和耐用性。

装备

2 x 黑格架Milanello 8100 602

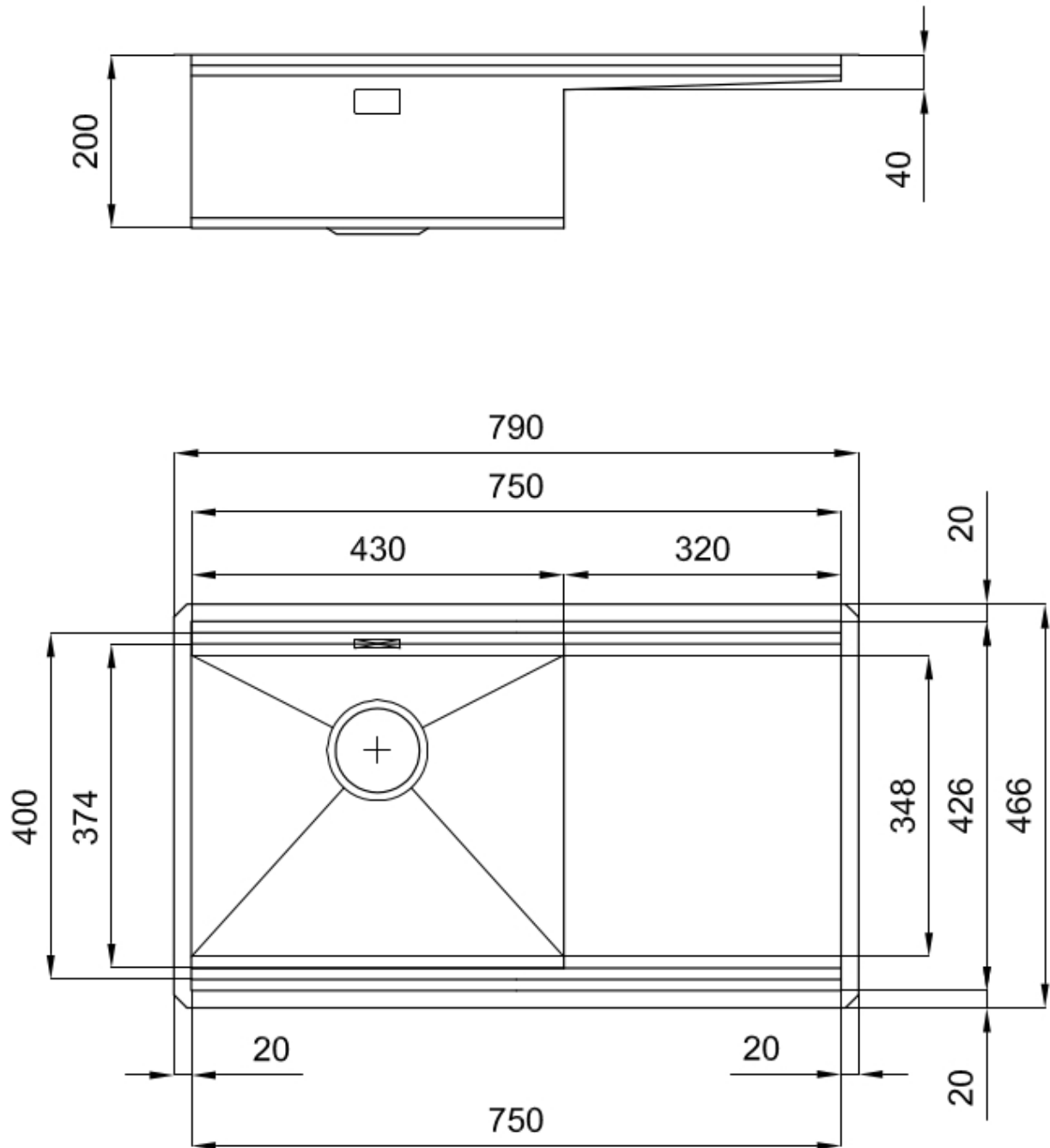

Milanello Optional accessories / Accessori opzionali

The "rails" system makes it possible to use a combination of numerous accessories. Grids, chopping boards, utensils' ranging system, bowls and containers of different dimensions can be alternated in the workspace with a simple gesture, and can easily be stacked, in order to be on hand at all times.

Il sistema di "corsie" rende possibile l'utilizzo combinato di innumerevoli accessori. Griglie, taglieri, portautensili, vaschette e contenitori di varie dimensioni si alternano nella zona di lavoro con un semplice gesto e possono essere impilati, sempre a portata di mano.



Milanello Level 1

Compatible accessories/Accessori compatibili:

8100 602
8631 300
8642 003
8644 004
8644 101
8657 001

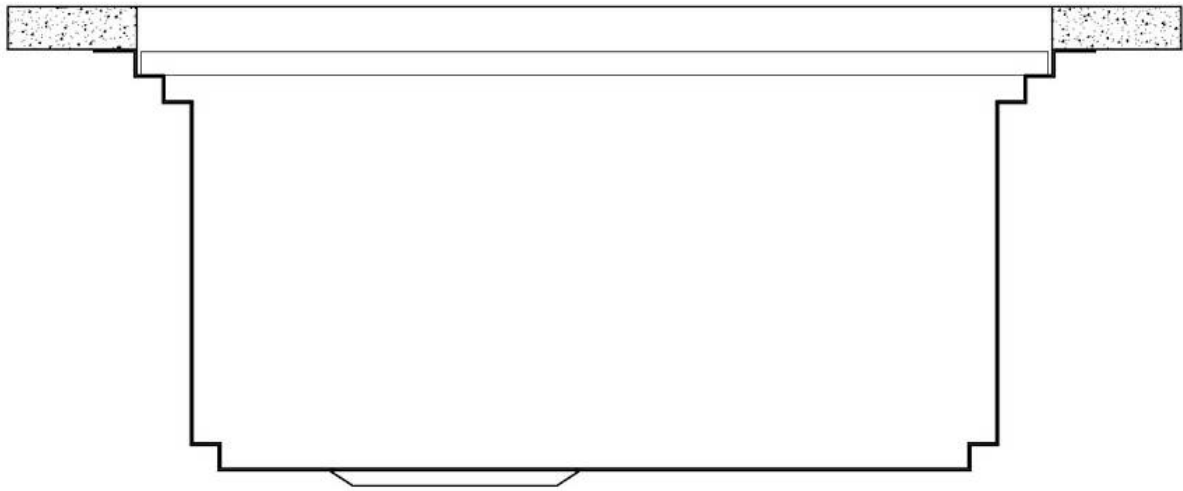

Milanello Level 2

Compatible accessories/Accessori compatibili:

8100 306

8156 000

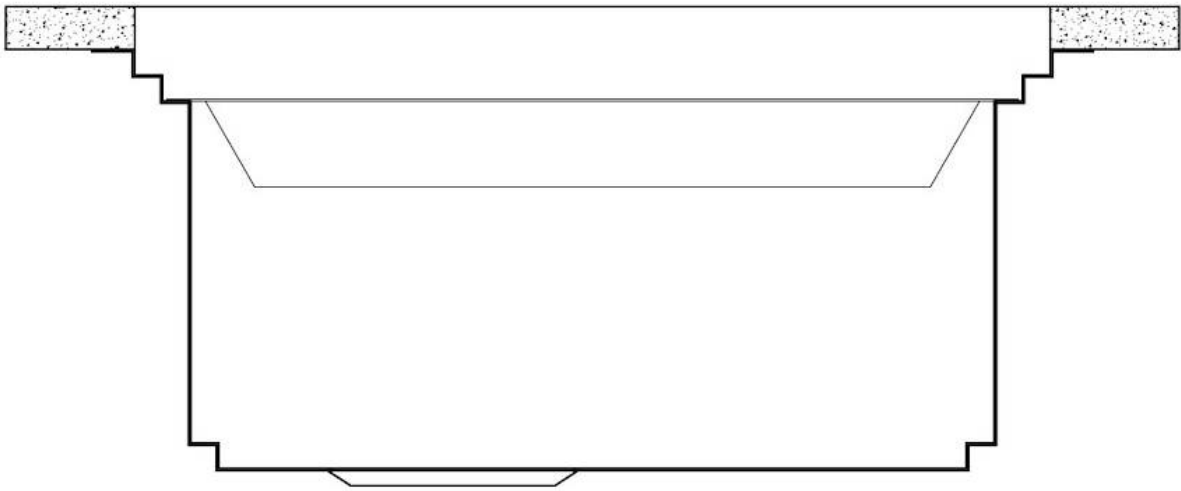

Milanello Level 3

Compatible accessories/Accessori compatibili:

8100 602

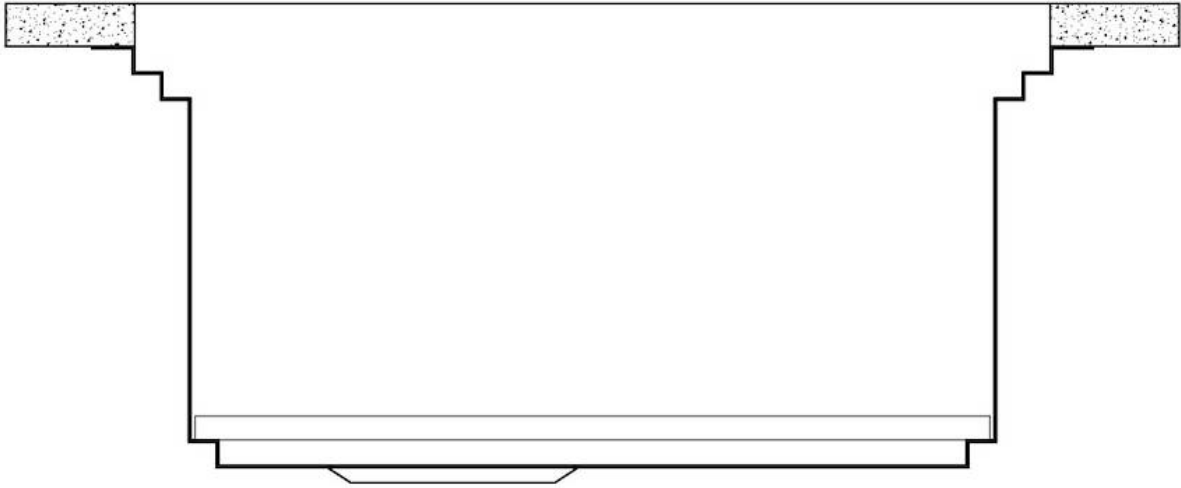

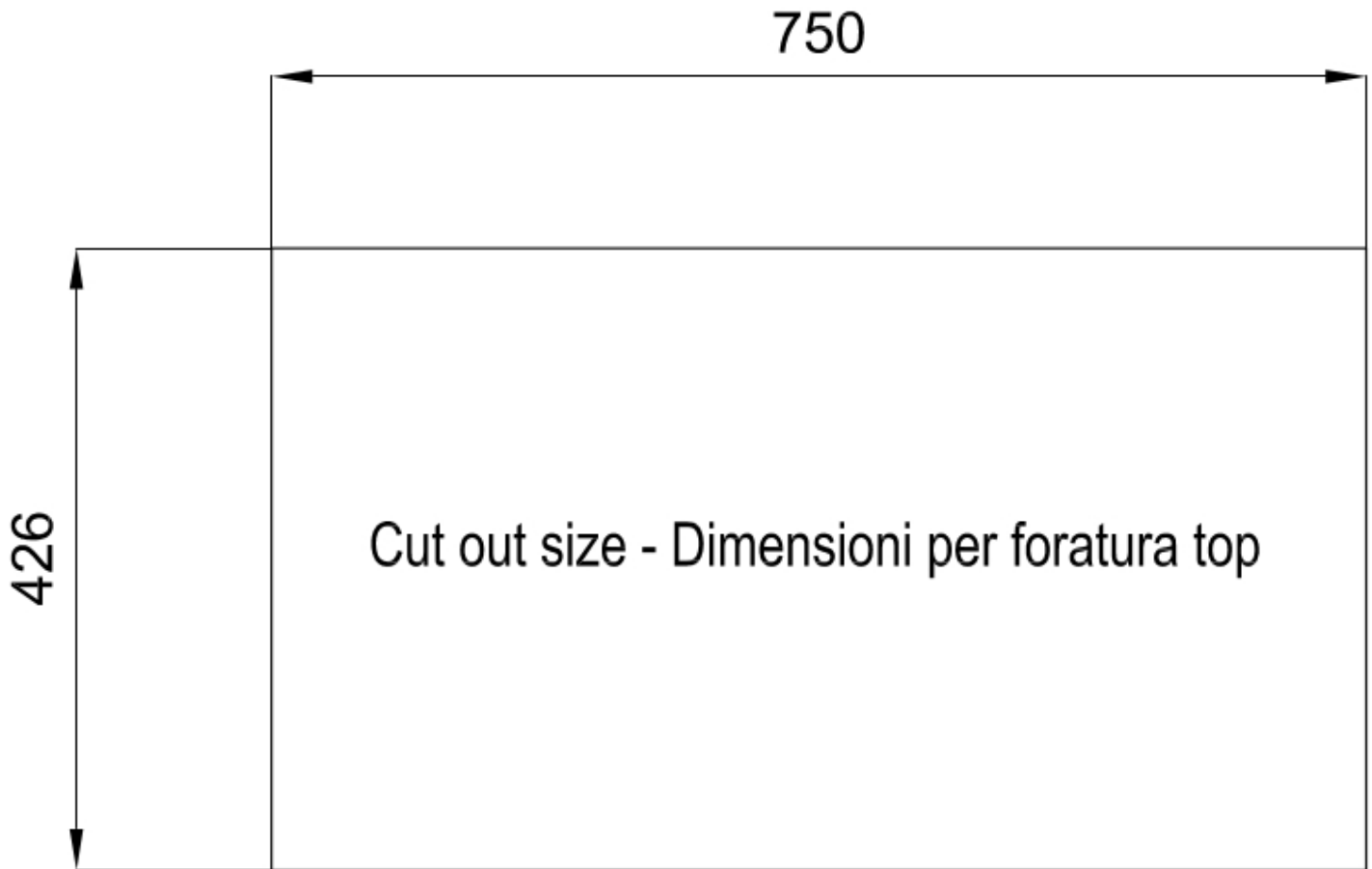

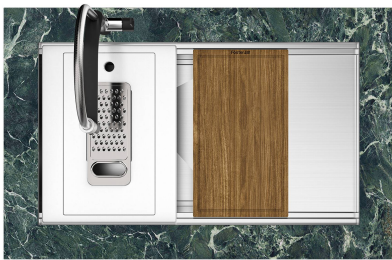
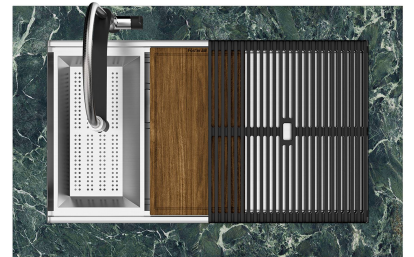
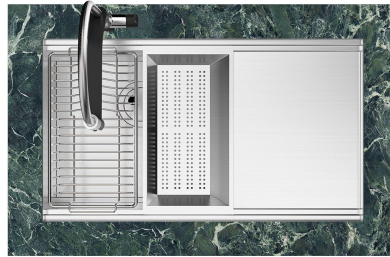
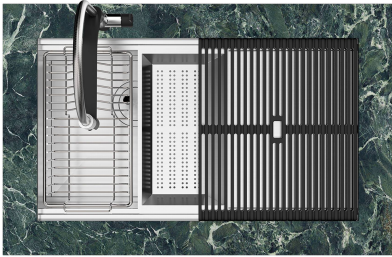
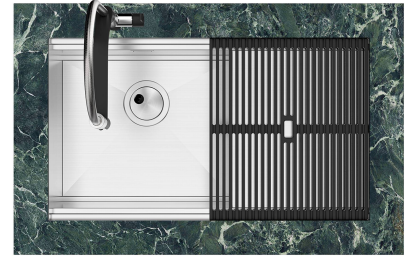

EQUIPMENT



黑格架 **Milanello**

8100 602

OPTIONAL ACCESSORIES



HPDE Twin 砧板
8644 101



HPDE 砧板
8657 001



不锈钢穿孔托盘
8156 000



不锈钢背板
8100 154

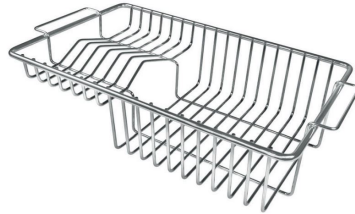

不锈钢背板
8100 306

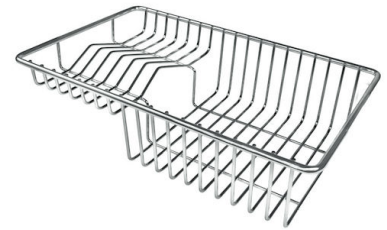

不锈钢背板
8100 303
* 仅与附件结合使用 8644 101



木砧板
8642 004



玻璃砧板
8631 300

RECOMMENDED PAIRINGS

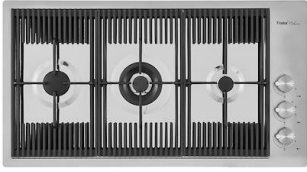

燃气灶 **Milanello**

7680 000



龙头 **Milanello**

8425 100